

EXPLODED ASSEMBLY VIEW (SIDE)

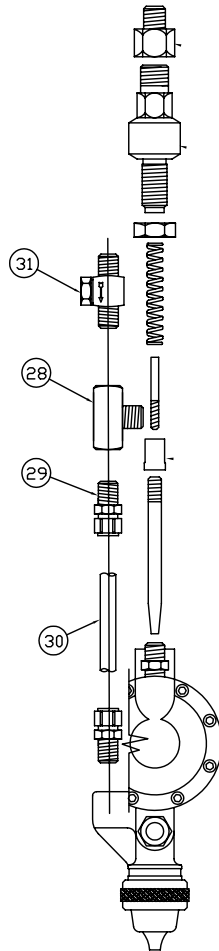

EXPLODED ASSEMBLY VIEW (FRONT)

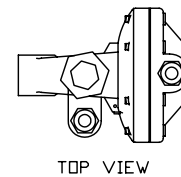

TOP VIEW

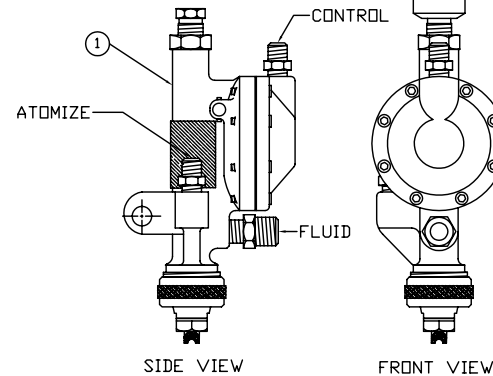

SIDE VIEW

FRONT VIEW

ITEM	QTY	PART NO	DESCRIPTION
1	1	KC-594-NBSSF	STRIPING GUN
1A	1	KC-119	FRAME
*	2	KC-110	NEEDLE PACKING (SET OF 2)
3	1	KC-109	PACKING NUT
4	1	KC-111	PACKING GLAND COVER
5	1	KC-113	TRIGGER PIN
*	6	KC-107	NEEDLE
7	1	KC-104	SPRING GUIDE
8	1	KC-102	LOCKING NUT
9	1	KC-117	DIAPHRAGM COVER
*	10	KC-103	SPRING, NEEDLE
11	1	KC-105	NEEDLE ADJUSTMENT STOP
12	1	KC-114	SPRING COTTER PIN
13	1	KC-112	TRIGGER
14	1	KC-115	DIAPHRAGM PLATE & PIN
15A	2	H-2008	NIPPLE, BRASS, 1/4 X 1/4 NPT
15B	2	KQH07-35S	PUSH LOCK FITTING, 1/4T X 1/4P
16	8	KC-118	DIAPHRAGM SCREWS
*	17	KC-116	DIAPHRAGM
18	1	F-03750695-SS	ADAPTOR, FLUID INLET 1/4 x 3/8"
19	1	AV-1	GASKET, FLUID TIP
**	20	MB-167	AIR CAP ADAPTER
**	21	MBC-198	AIR CAP RETAINING NUT
**	22	AV-1016	RETAINING NUT, KNURLED
**	23	S-23	AIR CAP SPRAY GUN 2-4"
**	24	WV-55	ADAPTOR, FLUID TIP
*	25	AV-1050-DSS	FLUID TIP 11/64
26	1	120-64	ADAPTER BRASS 3/8" F X 1/4" M
27	1	KC-140-1	NON BLEEDER (VALVE ONLY)
28	1	131-4	TEE 1/4" F X 1/4" M 1/4" F
29	2	1268-6	TUBE FITTING, 1/4P X 3/8T ST
30	1	4212-540N2	ATOMIZE AIR TUBE
31	1	KC-140-10	PLUG, 1/4" NPT, BLK
32	1	MB-47	LOCATING PIN

NOTE:
 1. (*) INCLUDED IN
 NEEDLE REPAIR KIT PART
 NUMBER KC-151
 2. (***) INCLUDED IN TIP
 REPAIR KIT PART NUMBER
 KC-152

TOLERANCES UNLESS OTHERWISE SPECIFIED:
 Angular $\pm 2^\circ$
 Fractional $\pm 1/16"$
 .X = ± 1
 .XX = ± 0.01
 .XXX = ± 0.005
 .XXXX = ± 0.0015

CONFIDENTIAL
 THIS DOCUMENT, INCLUDING ALL INFORMATION HEREIN, IS THE EXCLUSIVE AND CONFIDENTIAL PROPERTY OF ERNEST INDUSTRIES. THEREFORE THIS DOCUMENT IS NOT TO BE COPIED, REPRODUCED, OR DELIVERED TO OTHERS WITHOUT THE EXPRESS WRITTEN PERMISSION OF ERNEST INDUSTRIES.

Kelly-Creswell
 1221 Groop Rd.
 Springfield, OH 45504
 937-325-3978
KC Since 1937

DRAWN BY
 CDW
 APPROVED BY

DATE
 5-25-10
 DATE APPROVED

TITLE:
KC-594-NBSSF
 DESCRIPTION:
STRIPING GUN NBSSF

DWG NO./PART NO.
KC-594-NBSSF
 SCALE: N/A
 SIZE: A
 PAGE #: 1-2
 REV: A

NEEDLE REPAIR KIT PART
NUMBER KC-151



KC-110
NEEDLE PACKING (SET OF 2)
QTY-1

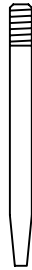

KC-107
NEEDLE, STAINLESS STEEL
QTY-1



KC-103
SPRING, NEEDLE
QTY-1

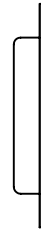

KC-116
DIAPHRAGM
QTY-1



AV-1
GASKET FLUID TIP
QTY-1



AV-1050-DSS
FLUID TIP SS
QTY-1

TIP REPAIR KIT PART
NUMBER KC-152



MB-167
AIR CAP ADAPTER
QTY-1

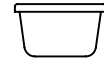

MBC-198
AIR CAP RETAINING HOOD
QTY-1

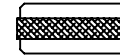

AV-1016
RETAINING NUT, KNURLED
QTY-1



S-23
AIR CAP SPRAY GUN 2-4"
QTY-1

TOLERANCES UNLESS OTHERWISE SPECIFIED:
Angular $\pm 2^\circ$
Fractional $\pm 1/16"$
.X = ± 1
.XX = ± 0.1
.XXX = ± 0.005
.XXXX = ± 0.0015

CONFIDENTIAL
THIS DOCUMENT, INCLUDING ALL INFORMATION HEREIN, IS THE EXCLUSIVE AND CONFIDENTIAL PROPERTY OF ERNEST INDUSTRIES. THEREFORE THIS DOCUMENT IS NOT TO BE COPIED, REPRODUCED, OR DELIVERED TO OTHERS WITHOUT THE EXPRESS WRITTEN PERMISSION OF ERNEST INDUSTRIES.

Kelly-Creswell
1221 Groop Rd.
Springfield, OH 45504
937-325-3978



Since 1937
DRAWN BY
CDW
APPROVED BY

DATE
7-14-10
DATE APPROVED

TITLE: KC-594-NBSSF			
DESCRIPTION: KC-151/KC-152 REBUILD KIT			
DWG NO./PART NO. KC-594-NBSSF			
SCALE: N/A	SIZE: A	PAGE #: 2-2	REV: A